

# BH CONNECTOR

4.0/8.0/12.0mm pitch/Disconnectable Crimp style connectors

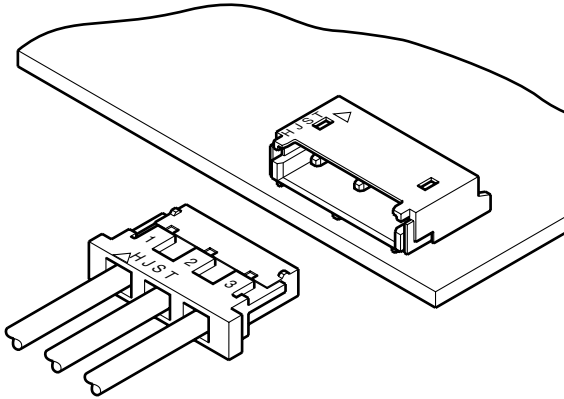

**Low profile connectors with high withstanding voltage, designed for connecting liquid crystal display back light lamps to their starters.**

- Low profile
- SMT configuration
- Applicable to special wires
- Headers with locating bosses
- Housing lock also serves as polarizing device

## Specifications

- Current rating: 1.0A AC, DC (AWG #22)
- Voltage rating: 600V AC, DC
- Temperature range: -25°C to +85°C  
(including temperature rise in applying electrical current)
- Contact resistance: Initial value/10m Ω max.  
After environmental testing/20m Ω max.
- Insulation resistance: 1,000M Ω min.
- Withstanding voltage: 1,800V AC/minute
- Applicable wire: AWG #28 to #22
- \* RoHS compliant products are published.
- \* Refer to "General Instruction and Notice when using Terminals and Connectors" at the end of this catalog.
- \* Contact JST for details.

## Standards

- Ⓜ Recognized E60389
- Ⓢ Certified LR20812

## PC board layout (viewed from component side)

### SMT type

(2 circuits 4.0mm pitch)

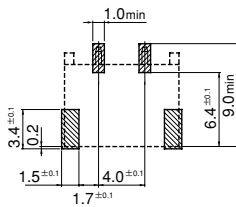

(2 circuits 8.0mm pitch)

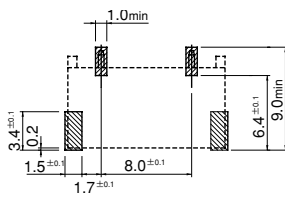

(2 circuits 8.0mm pitch with bosses)

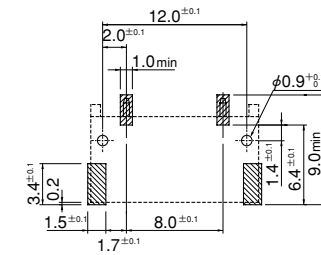

(2 circuits 8.0mm pitch plugged up)

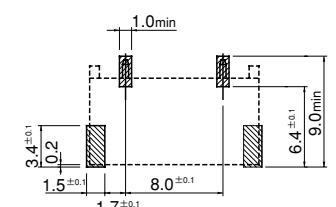

(2 circuits 12.0mm pitch)

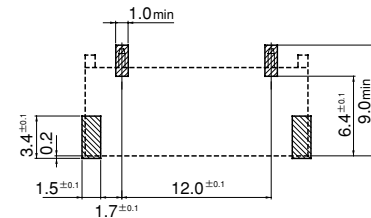

(3 circuits 4.0mm pitch)

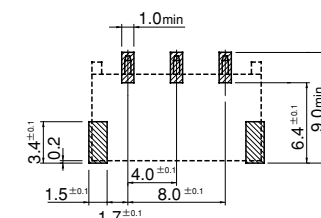

(3 circuits 4.0mm pitch plugged up)

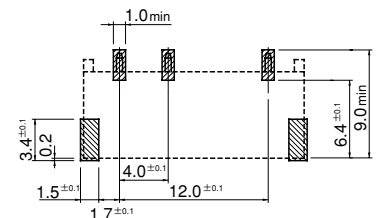

(4 circuits 4.0mm pitch)

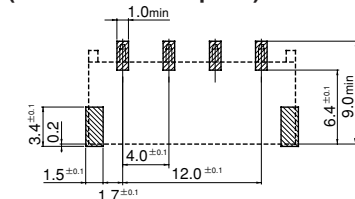

(4 circuits 4.0mm pitch with post removed)

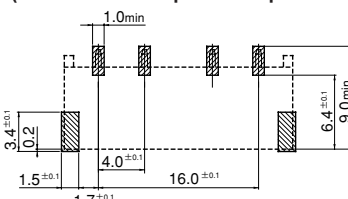

### Through-hole type

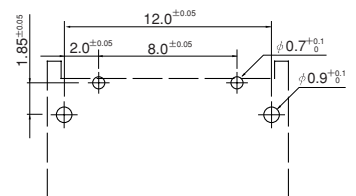

Note: 1. Tolerances are for pattern non-cumulative: ±0.05mm for all centers. Tolerance for hole size is ±0.1.

2. Hole dimensions differ according to the kind of PC board and piercing method. The dimensions above should serve as guideline. Contact JST for details.

# BH CONNECTOR

## Contact

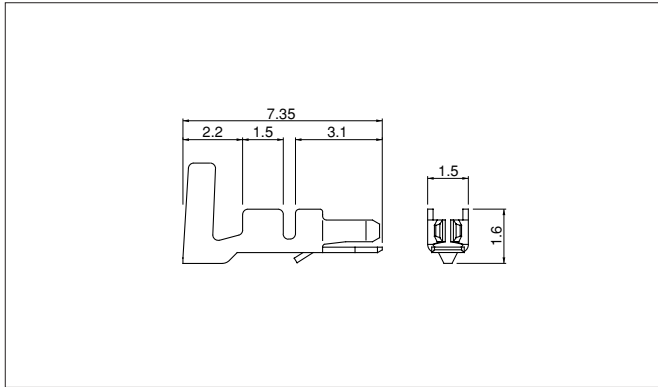

Model No.	Applicable wire		Insulation O.D. (mm)	Q'ty / reel
	mm <sup>2</sup>	AWG #		
<b>SBH-001T-P0.5</b>	0.08~0.33	28~22	1.6 ~2.4	4,000

### Material and Finish

Phosphor bronze, tin-plated (reflow treatment)

### RoHS compliance

Note: Wire conductors should be tin-plated annealed copper strands.

Contact	Crimping machine	Applicator		
		Crimp applicator	Dies	Crimp applicator with dies
<b>SBH-001T-P0.5</b>	AP-K2N	MKS-L	MK/SBH/M-001-05	APLMK SBH/M001-05
		*MKS-SC1-1	SC/SBH/M-001-05	APLSC SBH/M001-05

Note: \*Strip-crimp applicator

## Housing

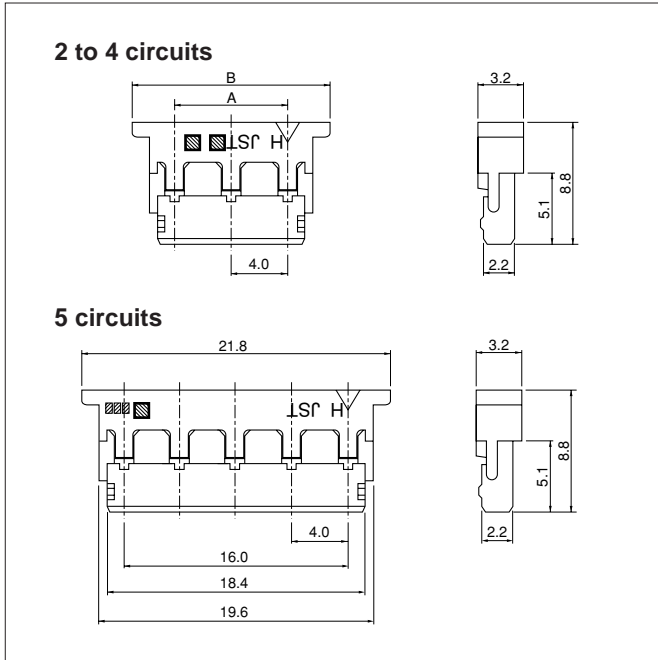

Circuits	Pitch (mm)	Model No.	Dimensions (mm)		Q'ty / bag
			A	B	
2	4	<b>BHR-02VS-1</b>	4.0	9.8	1,000
	8	<b>BHR-03VS-1</b>	8.0	13.8	1,000
	Note1) 8	<b>BHR-02(8.0)VS-1N</b>	8.0	13.8	1,000
3	12	<b>BHR-04VS-1</b>	12.0	17.8	1,000
	4	<b>BHR-03VS-1</b>	8.0	13.8	1,000
4	Note2) 4	<b>BHR-03(4-3)VS-1N</b>	12.0	17.8	1,000
	4	<b>BHR-04VS-1</b>	12.0	17.8	1,000
5	4	<b>BHR-05VS-1</b>	16.0	21.8	1,000

### Material

PA 66, UL94V-0, natural (white)

### RoHS compliance

Note: 1. BHR-02(8.0)VS-1N: 2 circuits 8.0mm pitch plugged up.  
2. BHR-03(4-3)VS-1N: 4 circuits 4.0mm pitch header with circuit No.3 plugged up.

## Through-hole type shrouded header

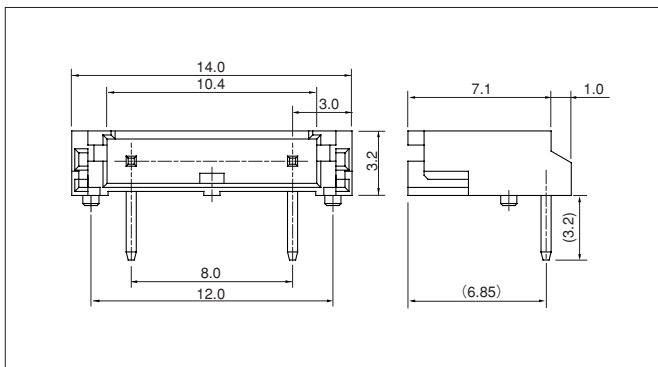

Circuits	Pitch (mm)	Model No.	Q'ty / tray
2	8	<b>S02(8.0)B-BHS</b>	1,000

### Material and Finish

Post: Copper alloy, copper-undercoated, tin-plated (reflow treatment)  
Wafer: PA, UL94V-0, natural (ivory)

### RoHS compliance

Note: This product displays (LF)(SN) on a label.  
Note: The applicable housing is "BHR-02(8.0)VS-1N" only.

## SMT type shrouded header

(2 circuits 4.0mm pitch)

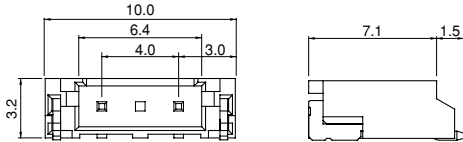

(2 circuits 8.0mm pitch)

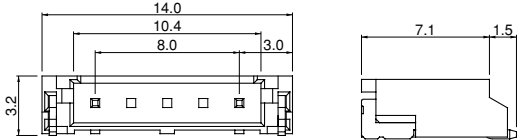

(2 circuits 8.0mm pitch with bosses)

Note 1)

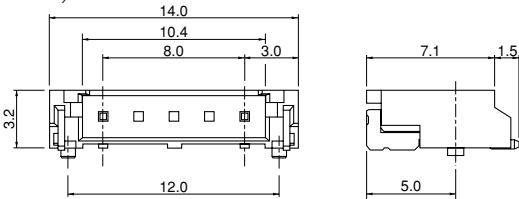

(2 circuits 8.0mm pitch plugged up)

Note 2)

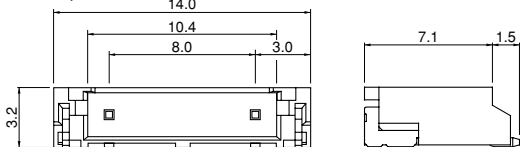

(2 circuits 8.0mm pitch with ribs against prying)

Note 4)

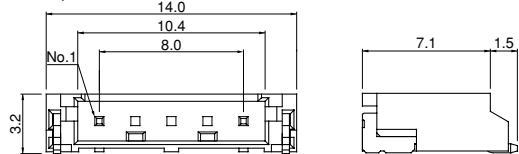

(2 circuits 12.0mm pitch)

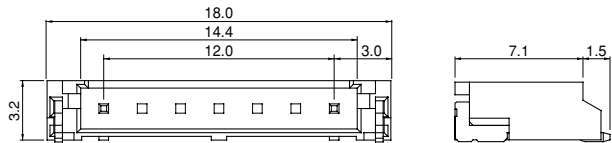

(3 circuits 4.0mm pitch plugged up)

Note 3)

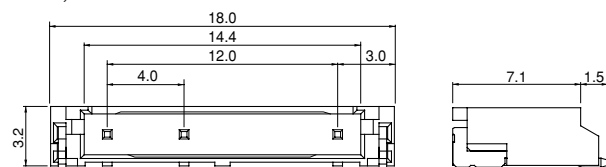

(3 circuits 4.0mm pitch)

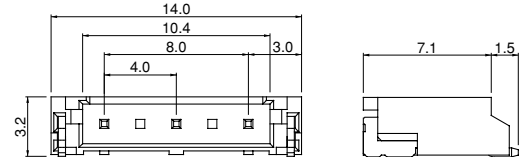

(4 circuits 4.0mm pitch)

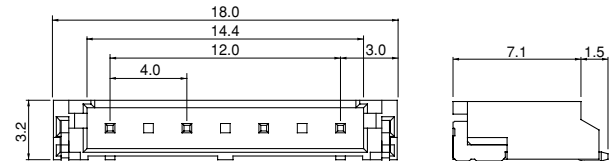

(4 circuits 4.0mm pitch with post removed)

Note 5)

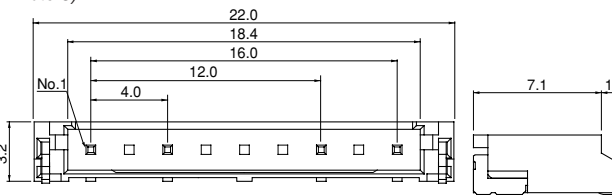

Circuits	Pitch(mm)	Model No.	Qty / reel
2	4	SM02(4.0)B-BHS-1-TB	1,000
	8	SM02(8.0)B-BHS-1-TB	1,000
	Note1) 8	SM02(8.0)B-BHS-TB	1,000
	Note2) 8	SM02(8.0)B-BHS-1N-TB	1,000
	Note4) 8	SM02(8.0)B-BHS-1R-TB	1,000
	12	SM02(12)B-BHS-1-TB	1,000
3	4	SM03(4.0)B-BHS-1-TB	1,000
	Note3) 4	SM03(7-D1)B-BHS-1N-TB	1,000
4	4	SM04(4.0)B-BHS-1-TB	1,000
5	Note5) 4	SM04(9-E2)B-BHS-1-TB	1,000

### Material and Finish

Post: Copper alloy, copper-undercoated, tin-plated (reflow treatment)  
 Wafer: PA, UL94V-0, natural (ivory)  
 Solder tab: Brass, copper-undercoated, tin-plated (reflow treatment)

**RoHS compliance** This product displays (LF)(SN) on a label.

Note: 1. Header with bosses. Contact JST for other circuits headers with bosses.

2. 2 circuits 8.0mm pitch plugged up.

3. 4 circuits 4.0mm pitch header with circuit No.3 plugged up.

4. Header with ribs against prying. Contact JST for other circuits headers with ribs against prying.

5. 5 circuits 4.0mm pitch header with circuit No.3 post removed.

6. The products listed above are supplied on embossed tape.

7. Products with bosses supplied in loose piece are also available. Contact JST for details.

# BH CONNECTOR

## Taping specifications

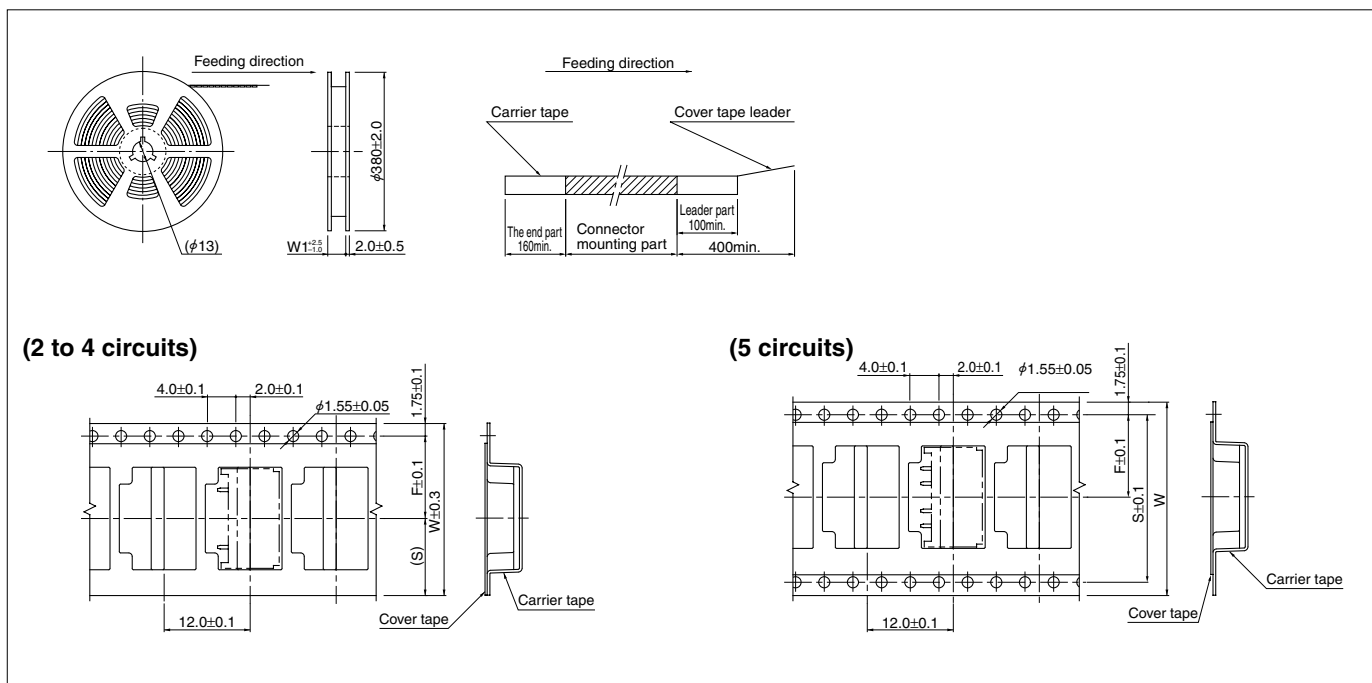

Circuits	Pitch (min)	Dimensions (mm)			Reel dimensions (mm)	Qty / reel
		F	S	W	W1	
2	4.0	7.5	6.75	16.0	25.5	1,000
	8.0	11.5	10.75	24.0	25.5	1,000
	12.0	11.5	10.75	24.0	25.5	1,000
3	4.0	11.5	10.75	24.0	25.5	1,000
4	4.0	11.5	10.75	24.0	25.5	1,000
5	4.0	14.2	28.4	32.0	33.5	1,000

**Note:**

1. Conforms to JIS C0806. Tape width and tape connector recess dimensions depend on the connector outer dimensions.
2. Specifications are subject to change without prior notice.