

SUR CONNECTOR

0.8mm pitch/Disconnectable Insulation displacement connectors

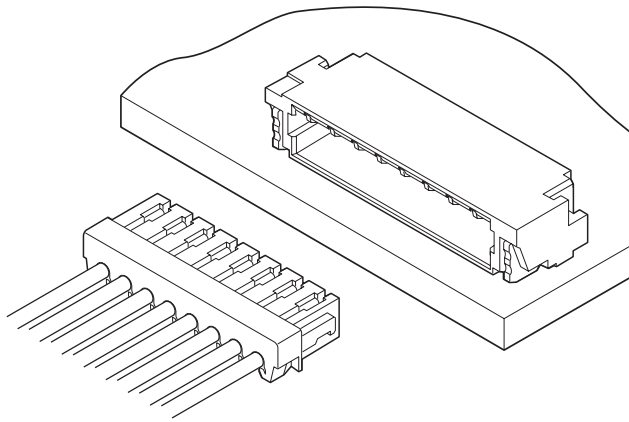

The world's first 0.8mm pitch wire-to-board insulation displacement connector. Side entry type is only 3.9mm depth and 1.75mm height after mounting on the PC board, and top entry type is only 2.2mm depth and 3.9mm height.

Compared to the conventional 1.0mm pitch SSR connector, occupation space on the board is reduced by 34% (side entry type).

- 3-point grip construction
- Super fine wires are applicable
- Shrouded header
- Twin U-slot insulation displacement section

Specifications

- Current rating: 0.5A AC, DC (AWG #32)
0.2A AC, DC (AWG #36)
- Voltage rating: 30V DC
- Temperature range: -25°C to +85°C
(including temperature rise in applying electrical current)
- Contact resistance: Initial value/20m Ω max.
After environmental testing/40m Ω max.
- Insulation resistance: 100M Ω min.
- Withstanding voltage: 200V AC/minute
- Applicable wire: Conductor size/AWG #32, #36
Conductor/7 strands,
tin-coated copper alloy
Insulation O.D./0.39mm
- * RoHS compliant products are published.
- * Refer to "General Instruction and Notice when using Terminals and Connectors" at the end of this catalog.
- * Contact JST for details.

Standards

Recognized E60389

Certified LR20812

PC board layout (viewed from component side) and Assembly layout

Top entry type

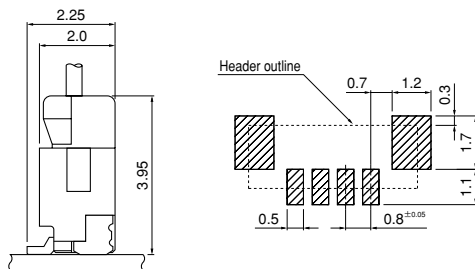

Side entry type

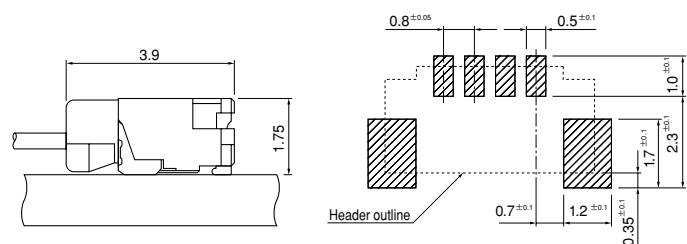

Note: 1. Tolerances are non-cumulative: $\pm 0.05\text{mm}$ for all centers.
2. Dimensions above should serve as a guideline. Contact JST for details.

SUR CONNECTOR

Receptacle

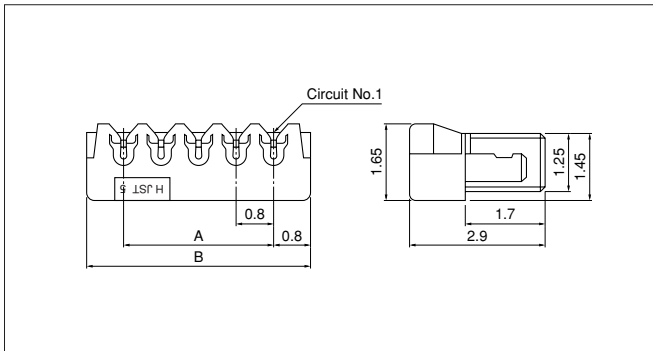

Circuits	Model No.		Dimensions (mm)		Q'ty/box
	#32(Natural)	#36(Lemon yellow)	A	B	
2	02SUR-32S	02SUR-36L	0.8	2.4	2,000
3	03SUR-32S	03SUR-36L	1.6	3.2	2,000
4	04SUR-32S	04SUR-36L	2.4	4.0	2,000
5	05SUR-32S	05SUR-36L	3.2	4.8	2,000
6	06SUR-32S	06SUR-36L	4.0	5.6	2,000
8	08SUR-32S	08SUR-36L	5.6	7.2	2,000
10	10SUR-32S	10SUR-36L	7.2	8.8	2,000
12	12SUR-32S	12SUR-36L	8.8	10.4	2,000
14	14SUR-32S	14SUR-36L	10.4	12.0	2,000
15	15SUR-32S	15SUR-36L	11.2	12.8	2,000
16	16SUR-32S	16SUR-36L	12.0	13.6	2,000
17	17SUR-32S	17SUR-36L	12.8	14.4	2,000
20	20SUR-32S	20SUR-36L	15.2	16.8	2,000
22	22SUR-32S	22SUR-36L	16.8	18.4	2,000

Material and Finish

Contact: Copper alloy, tin-plated (reflow treatment)
Housing: PA, UL94V-0

RoHS compliance

Shrouded header

Top entry type

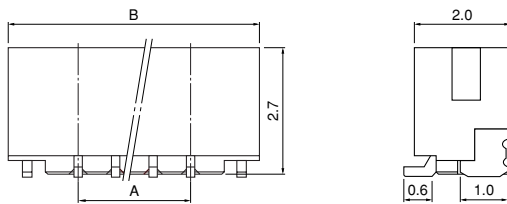

Side entry type

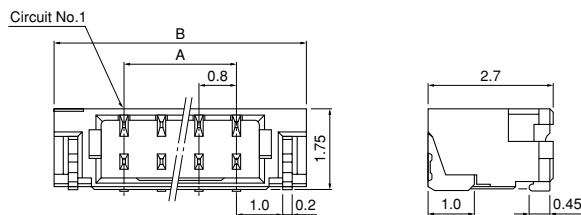

Circuits	Model No.		Dimensions (mm)		Q'ty/ reel	
	Top entry type	Side entry type	A	B	Top entry type	Side entry type
2	BM02B-SURS-TF	SM02B-SURS-TF	0.8	3.8	2,500	3,500
3	BM03B-SURS-TF	SM03B-SURS-TF	1.6	4.6	2,500	3,500
4	BM04B-SURS-TF	SM04B-SURS-TF	2.4	5.4	2,500	3,500
5	—	SM05B-SURS-TF	3.2	6.2	—	3,500
6	—	SM06B-SURS-TF	4.0	7.0	—	3,500
8	BM08B-SURS-TF	SM08B-SURS-TF	5.6	8.6	2,500	3,500
10	BM10B-SURS-TF	SM10B-SURS-TF	7.2	10.2	2,500	3,500
12	BM12B-SURS-TF	SM12B-SURS-TF	8.8	11.8	2,500	3,500
14	—	SM14B-SURS-TF	10.4	13.4	—	3,500
15	BM15B-SURS-TF	SM15B-SURS-TF	11.2	14.2	2,500	3,500
16	—	SM16B-SURS-TF	12.0	15.0	—	3,500
17	—	SM17B-SURS-TF	12.8	15.8	—	3,500
20	BM20B-SURS-TF	SM20B-SURS-TF	15.2	18.2	2,500	3,500
22	—	SM22B-SURS-TF	16.8	19.8	—	3,500

Material and Finish

Contact: Copper alloy, copper-undercoated, tin-plated (reflow treatment)
Wafer: PA, UL94V-0, natural
Solder tab: Brass, copper-undercoated, tin-plated (reflow treatment)

RoHS compliance This product displays (LF)(SN) on a label.
Note: The products listed above are supplied on embossed-tape.

SUR CONNECTOR

Taping specifications

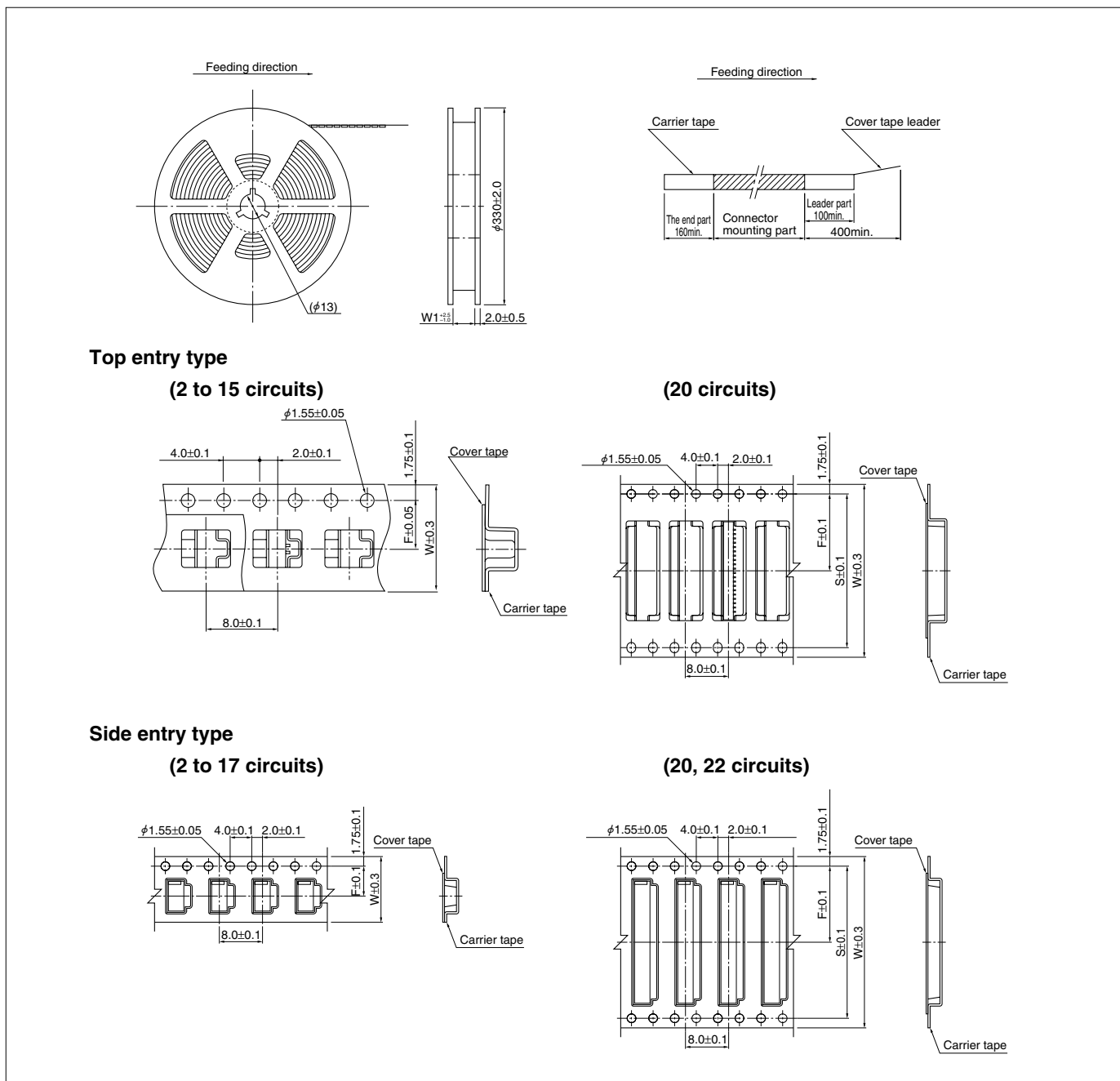

Circuits	Taping dimensions (mm)			Reel dimensions (mm)		Q'ty / reel	
	F	S	W	W1	Top entry type	Side entry type	
2 to 4	5.5	—	12.0	13.5	2,500	3,500	
5 to 8	7.5	—	16.0	17.5	2,500	3,500	
10 to 17	11.5	—	24.0	25.5	2,500	3,500	
20, 22	14.2	28.4	32.0	33.5	2,500	3,500	

- Note:
- Specifications conform to JIS C 0806. The tape width, connector recess hole dimensions, etc. are determined by the number of circuits and external shape of the connector to be loaded.
 - Specifications are subject to change without prior notice.